

# Data Sheet



Article number: 021816011289

Description: Clamp with bracket and rubber  
SPGU 6011. 289/30 SK

## Measures

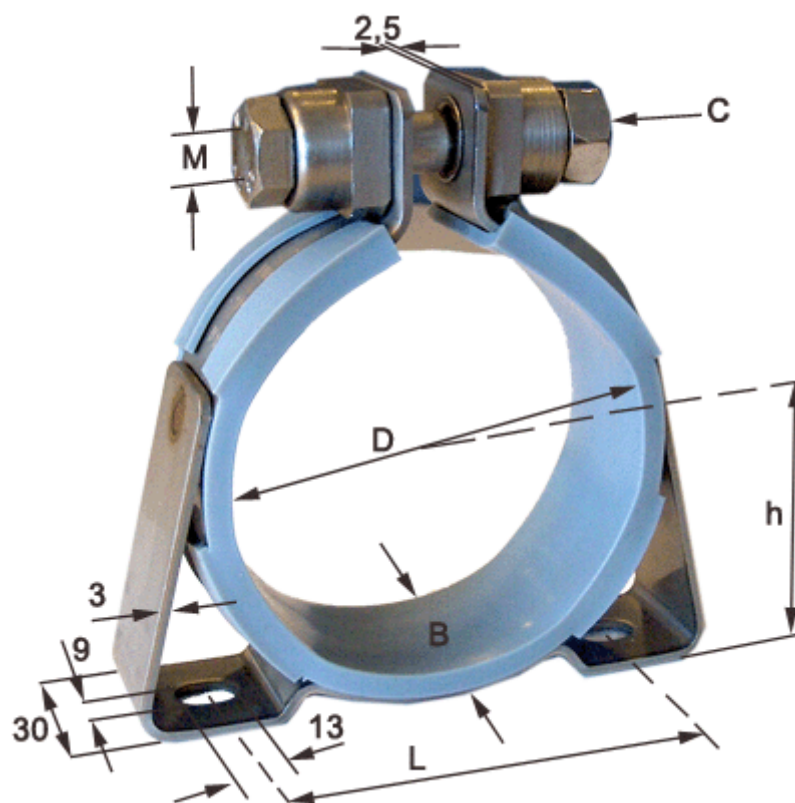

C (screw type) = SK hexagon screw

Diameter D = 289

h = 153

L = 280

Width B = 30